

Varenummer: 204080M24150A1U

Beskrivelse: E+G Justerfod
GN 40-80-M24-150-A1-U

Note: U Uden møtrik, sekskant i toppen, spændeflade i bunden

Mål

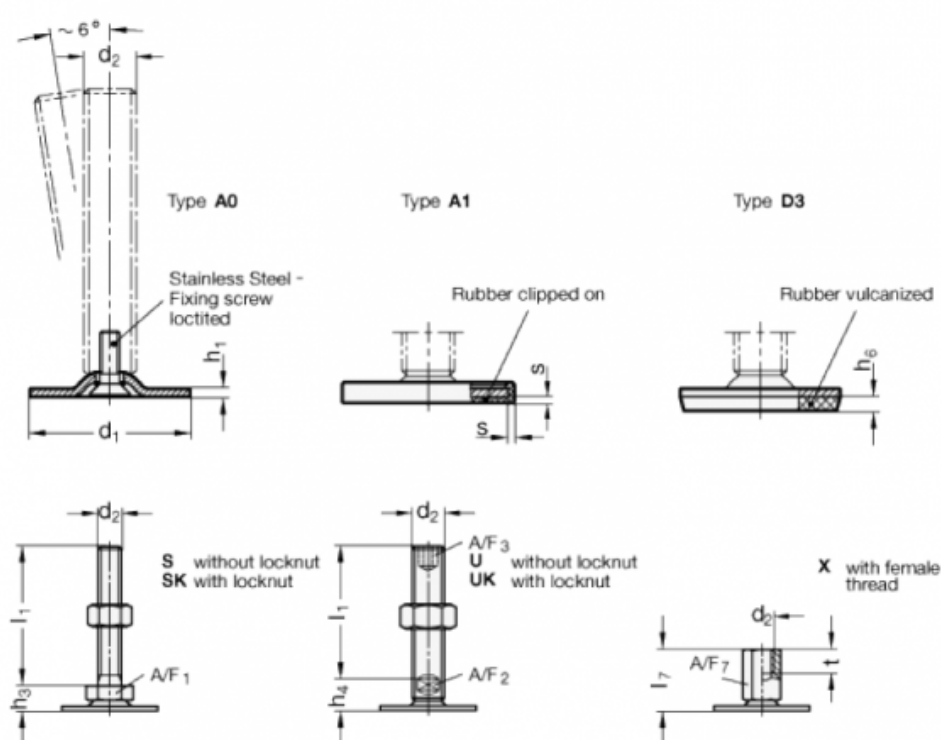

A/F2 = 19
A/F3 = 12
d1 = 80
d2 = M24
h1 = 3
h4 = 21
h6 =
l1 = 150

s = 2